

Horsley 24 / 360 rotational camera



Principles of operation and operating instructions

1.1 Principle of operation

The Horsley 24 / 360 camera employs the moving film principle to obtain panoramic shots of up to 360 degrees.. The principle of operation is well known and has been in use for at least a century. Examination of Brian Coe's excellent book "Cameras", shows the Damoizeau Cyclographique camera dated 1890 that uses this principle, followed by the Cirkut camera of 1904, some of which are still I use to the present day. The basic operation of this type of camera is described with reference to the drawing below that uses an idealised 24 mm lens.

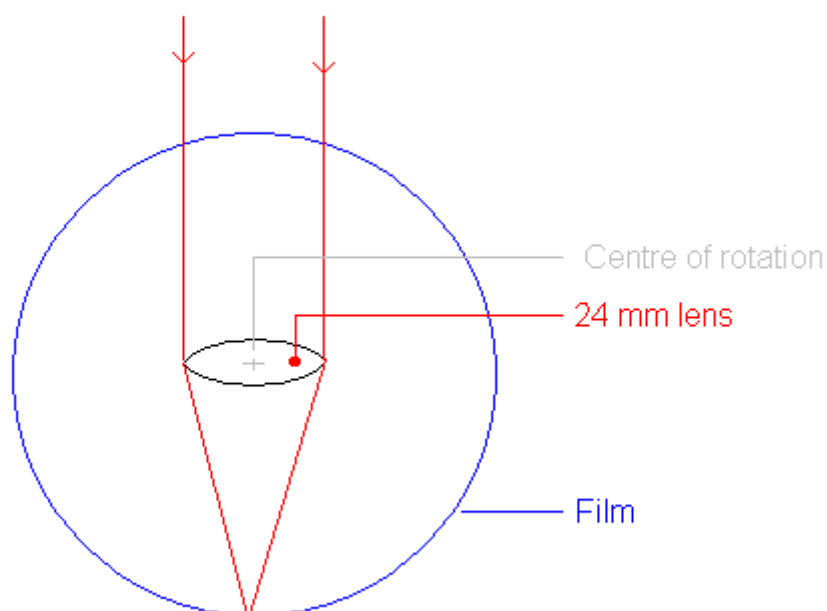

Drawing 01

For the purpose of this explanation we are using a film that will permit light to pass through itself so that an image may be formed at the focal point of the lens. It should be noted that this is theoretical film and will not be used in the final camera !

To obtain a focussed image the film must be 24 mm from the node point of the taking lens as shown. If the lens is now rotated through 360 degrees , a focussed image will be produced over 360 degrees of the film. If the cylinder of film is now "opened up", it will have a length of $24 \times 2 \times \pi$, or 151 mm. Since our "theoretical " film will not pass light, we must find a means of pulling exactly 151 mm of film past the focussed image as it rotates through 360 degrees.

A simplified drawing of the technique employed is shown on Drawing 02 on the following page.

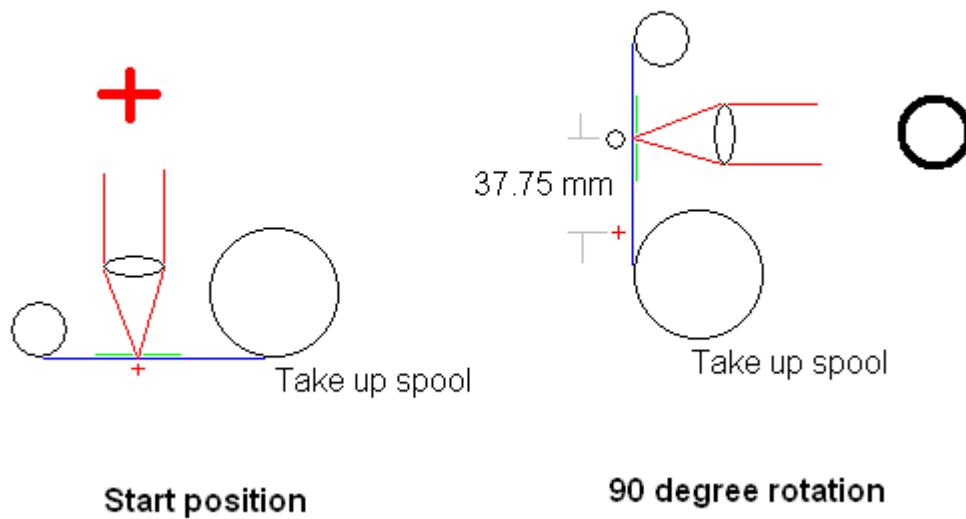

At the start of the 360 degree scan the red cross will be focussed on the film as shown. When the camera is rotated through 90 degrees to point at the black ring the image will be located on the film as shown, however the latent image of the red cross will now have moved by $151/4$ or 37.75 mm if we are to obtain a negative length of 151 mm. Which is the value required to produce a stationary image as the camera rotates.

In practice, the take up spool does not rotate, but the camera body turns on the axis of the spool, the diameter of the spool determining the length of film pulled through during the 360 degree rotation.

The drawing shows that the film is exposed through a slot, this being a critical part of the design for two reasons.

Firstly the concept of a stationary image being projected onto the film is theoretically valid only for a vertical line of zero width and as this line is widened into a slot, a simple trigonometrically analysis of the ray diagram shows that the performance will be degraded. In practice this effect does not have a serious effect on the final result ion for slot width less than 2 mm.

Secondly the amount of film to be pulled past the slot is a direct function of the focal length and as has been explained , it will be 151 mm for a true 24 mm lens. In practice the true focal length of a nominal 24 mm lens is usually nearer 25 mm, this therefore requires a negative length of $25 \times 2 \times \pi$ or 157 mm

The slot width also defines the effective shutter speed and this will be examined in the following section

1.2 Shutter speed control

The shutter speed on a rotational camera is defined by two factors , these being :-

- a) the speed of rotation
- b) the exposure slot width

Considering firstly the speed of rotation. It may be seen that in theory the upper limit will be imposed by the fact that the camera is not dynamically balanced and if it rotated too rapidly it would try to throw itself off the tripod. In practice this problem is never reached and a top speed of 4 seconds for a 360 degree scan is employed. An 8 second scan is also available, this being selected via the drive motor control box which is described in a later section. The slot width should not exceed 2 mm for reason previously explained and in practice a slot width of 0.7 mm is employed in this design.

The effective shutter speed for a 0.7 mm slot fitted to a camera rotating at the rate of 90 degrees per second (4secs for 360 degrees)

If the camera rotates at the rate of 360 degrees in 4 seconds , it can be seen that during this time the film will have advanced by 157 mm, hence the speed of film past the exposure slot is $157/4$ or approx. 39 mm per second. It may therefore be seen that each part of the film will be exposed for $0.7 \times 1/39$ sec or app. 8 ms, or in photographic terms approximately $1/50$ sec. By reducing the rotation rate to 8 seconds the exposure time will increase to app $1/25$ sec.

The question will be asked, why not use smaller slot width since this would allow a shorter exposure and be more trigonometrically correct, thus improving the definition. The reason that the slot width cannot be reduced is due to the effect of "banding", a term that will now be examined.

It has been shown that the exposure time for each vertical strip of negative is a function of the slot width and the speed of rotation.. In practice a constant speed of rotation is vital to obtain an evenly exposed negative and it may be seen that, for example, if the speed momentarily dropped from say 39 mm per sec. To 30 mm per sec, then the exposure time would increase for the duration of the event and the result would be a vertical band of greater density than it's surroundings . The speed of rotation may be affected by several factors such as a minor change in friction in the drive train, however by averaging out the pull through speed over a wider slot these effects are minimised and so in practice a 0.7 mm slot is an optical compromise between theoretically improve definition and the elimination of banding. It is well known that all engineering is a compromise. This is a perfect example.

2.1 The camera controls

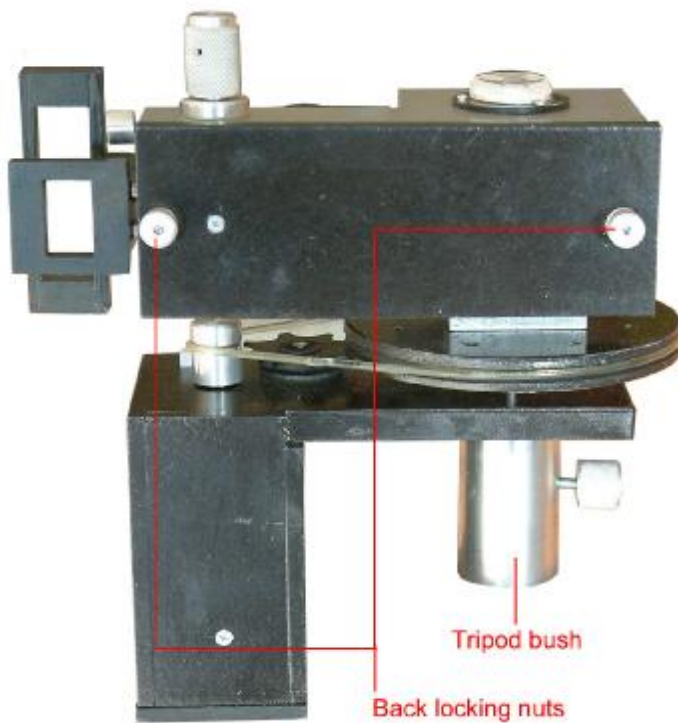
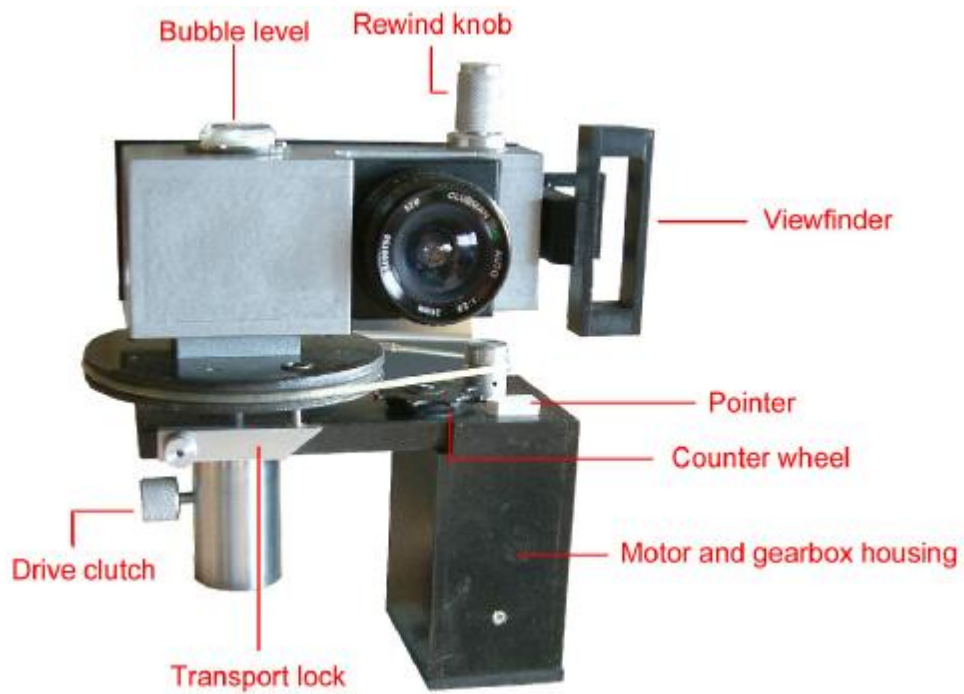

2.2 Control box

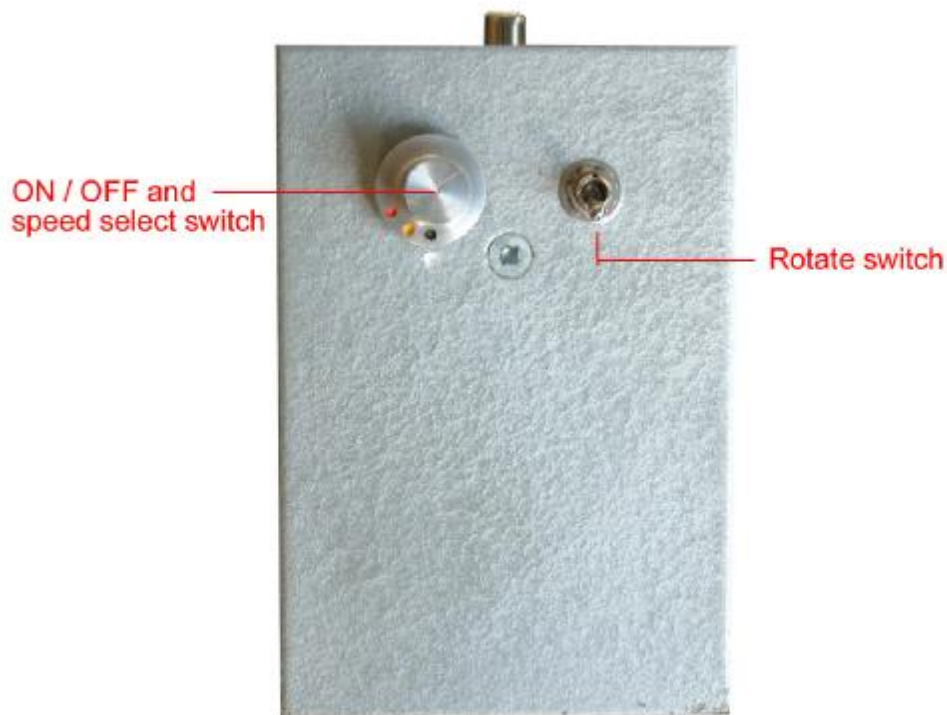

Two switches are provided.

The **ON / OFF** switch has three colour coded positions
Black = OFF Yellow = 1/25sec Red = 1/50 sec

The **Rotate** switch is spring loaded and is operated when wish to take a shot.

The control box is linked to the motor and gearbox assembly via a 2 mtr. Cable. This length is necessary so that the photographer may “walk round” behind the camera during rotation, thus avoiding a 90 degree segment of the photographers body !

The motor drive is powered by a set of 4 x AA alkaline batteries that are located in the control box and are accessed by removing a screw that is visible on the underside of the box.

It is essential that these batteries are inserted in the correct manner , this being defined on the next page.

2.3 Battery positions

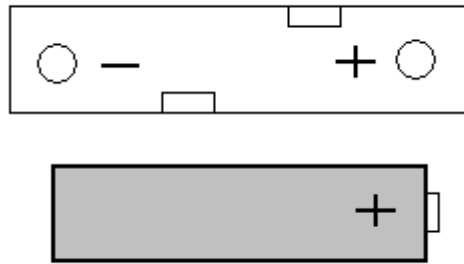

Each battery fits into an individual holder as shown above, the polarity being indicated by the markings next to the fixing holes.

The set of four batteries is inserted as shown below. The alternate LEFT RIGHT layout should be noted.

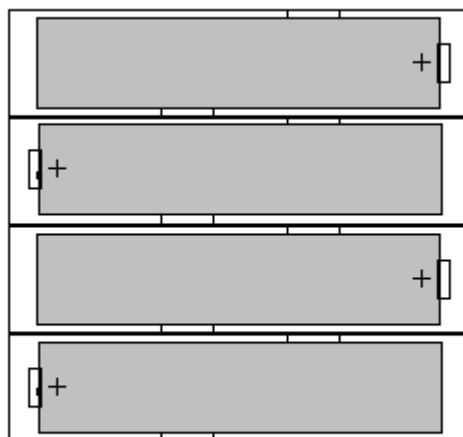

3 Loading the camera

The loading procedure for the camera will now be described and it is assumed that this operation will be performed with reference to the illustration on page 5.

1. The **transport lock** should be left engaged as shown in the illustration.
2. the knurled **drive clutch** is unscrewed about 3 turns.
3. The camera should be mounted on a tripod
4. The body should now be in the position shown.

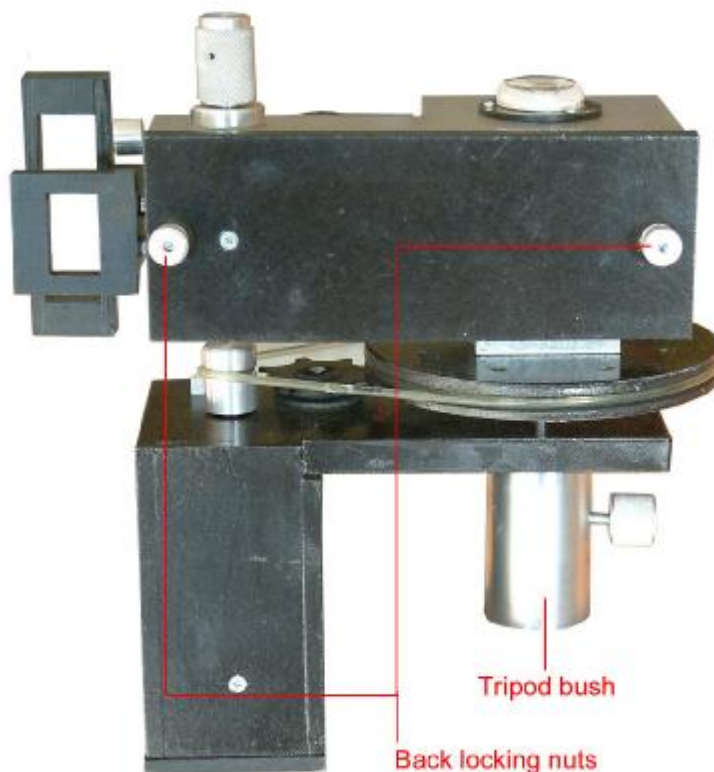

Remove the back of the camera by unscrewing the two **Back locking nuts**

This will then expose the cassette loading location and the take up spool as shown on the next page

3.1 Cassette insertion

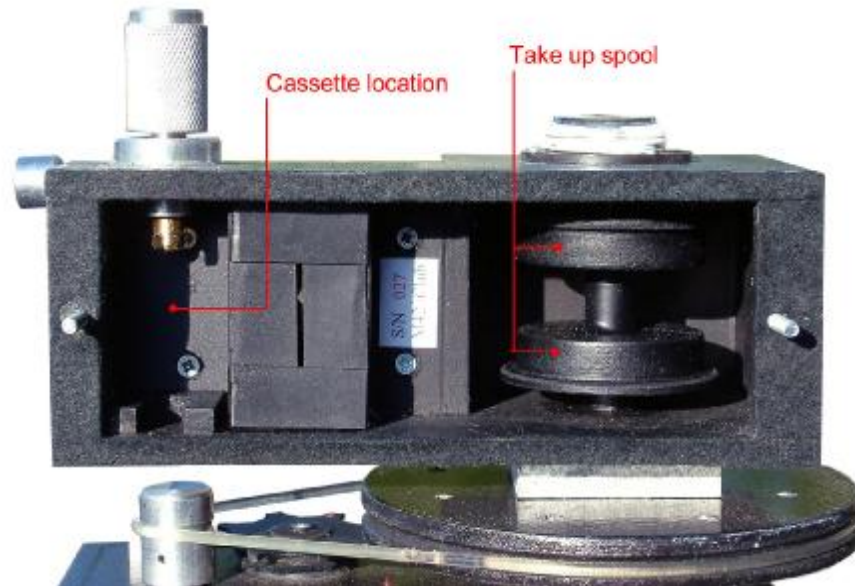

To load the cassette the rewind knob must be lifted upwards. It is the locked in this location by the rewind lock and left in this state since it eliminates another possible cause of friction when the film is being pulled out of the cassette.

The rewind knob is only engaged with the cassette when the film needs to be rewound.

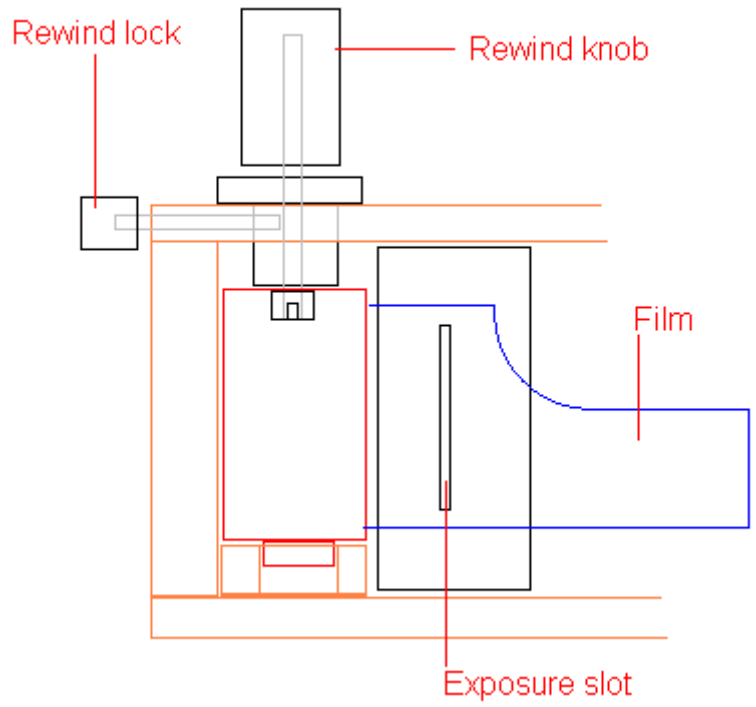

3.2 Attaching the film to the take up spool

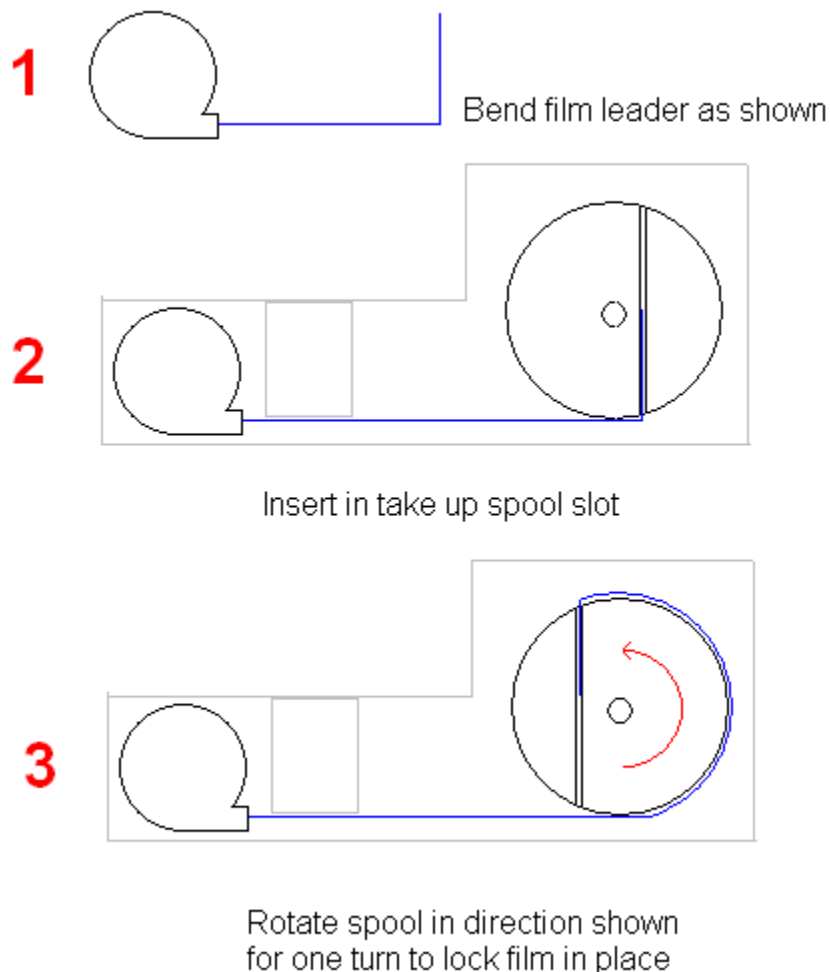

The leader of the film is fed into the slot as shown. When in place the take up spool is rotated by hand in the direction of the arrow until the film has completed one revolution and the leader is now covered by the next layer of film.

The drive clutch should now be screwed in, thus locking the take up spool assembly to the tripod mount.

The back of the camera may now be fitted, noting that the pressure plate must be over the exposure slot. *On all models after S/N 029 a polarising pin is installed thus preventing incorrect fitting often back.*

At this point the camera should be rotated by 360 degrees using the motor drive and this will bring unexposed film into the correct working position. To perform this operation it is necessary to release the transport lock to disengage the locking pin in the main pulley.

4 Film layout

Unlike a normal camera , your film does not provide 24 or 36 exposures, since with the film being pulled past the exposure slot, scans of any length may be made.. Although with a rotational panoramic camera it is just as possible to take a 60 degree shot as a 360 degree shot, hence it is necessary to note the length of film used , rather than count exposures which is virtually meaningless.

As an example, the lengths of film used for varying degrees of rotation are shown below for a 24 mm lens

Degrees of rotation	Length of film used (mm)
90	39
180	79
270	118
360	157
540	235

It should be noted that after setting up, a 36 exposure film will provide approx. 120 mm of emulsion. This equates to 8 complete 360 degree panoramas.

From the table it may be seen that a normal frame counter is not applicable, however in this design it is replaced by a film used counter, this taking the form of an 8 lobed wheel that indexes 1 position for each revolution of the camera.. The wheel has two coloured markers on the periphery, a green mark that is set at the starting point and a red mark that will line up with the pointer when the full length of film has been used. It should be noted that this assumes the use of a 36 exposure film.

The wheel may be rotated manually to set the green mark next to the pointer at the start of a new film before the transport lock is released,

A factor that must always be considered when using a rotational camera is the fact that they do not have instantaneous acceleration and so if you wish to take a 360 degree scan it is advisable to allow about a 60 degree start up length to allow the camera to stabilise at it's final speed.

Summary of setting up instructions

- 1 Load film as previous instructions
2. Close back and lock the drive clutch. Failure to do this will result in the camera rotating but the film will not be pulled past the exposure slot.
3. Slacken the knurled nut holding the transport lock in position, this will permit it to fall vertically and disengage the locking pin that was engaged in the main pulley.
4. Rotate the camera by 360 degrees to bring unexposed film up to the exposure slot ready for the first shot.
5. Set the film counter to the green marker (see page 11)
6. Lift the rewind knob and lock it in the fully raised position with the rewind lock (see page 9). The lens cap should be placed between shots to minimise light spill over from the exposure slot during extended periods when the camera is not in use.

When the film has been used, it is wound back into the cassette by releasing the rewind lock and allowing the rewind knob to drop down such that the fork assembly at the end of the shaft will locate on the cassette spool (see diagram on page 9). To perform this operation it is necessary to disengage the drive clutch to permit free rotation of the take up spool.

Reminder Before rewinding the lens cap must be fitted.

7 Focus setting. With a panoramic camera it is assumed that the lens will always be set to take distant views and for this function the lens should be set at the hyperfocal distance of 3 mtr., which ensures sharp focus from 1.5 mtr, to infinity at f4 and above. It is not acceptable to move this focal point closer , since as an example , the focus setting at 1 mtr. Will move the lens, hence the nod point by approx. 1 mm. In theory this would demand that the film should be pulled through by an additional 6 mm. Setting the focus at 1 mtr. Will therefore degrade the performance

Reminder. Always leave the lens set at 3 mtr.

8 The lens cap. This simple component will have a dramatic effect on your results. Three important points should be noted

- A Always remove the lens cap before taking a shot.
- B Always replace the lens cap after you have taken a shot and finally
- C Always have the lens cap in place when rewinding the film otherwise you will expose the shots you have just taken.

9 The viewfinder

The finder provided is a simple frame finder that delineates only the vertical angle of view. By rotating the complete assembly, camera and motor drive, the horizontal angle may be previewed.

10 Transport lock.

After use the camera should be rotated to permit the pin on the transport lock to engage with one of the holes in the main pulley. This will prevent film being pulled past the exposure slot due to accidental rotation of the body during transport..

11 Slot cleaning

The exposure slot should be checked for dust and odd particles before loading a new film. This can be performed by opening the lens to f 2.8 and looking against the light to note a clean slot. If a particle of hair, as an example, was to fall into the slot and reduce the effective width, it can be seen that the effective exposure at this point will be reduced. The result will be a line of underexposed emulsion that will run the full length of the film.

12 Belt changing

In the vent of a drive belt failing a new one is fitted as follows :-

- A Mount the camera on a tripod to give it support
- B Unscrew the drive clutch.
- C The body may now be lifted vertically clear from the motor / gearbox and tripod assembly.
- D A new belt may now be passed over the ¼" support shaft and fitted to the main and drive pulley.

Summary sheet

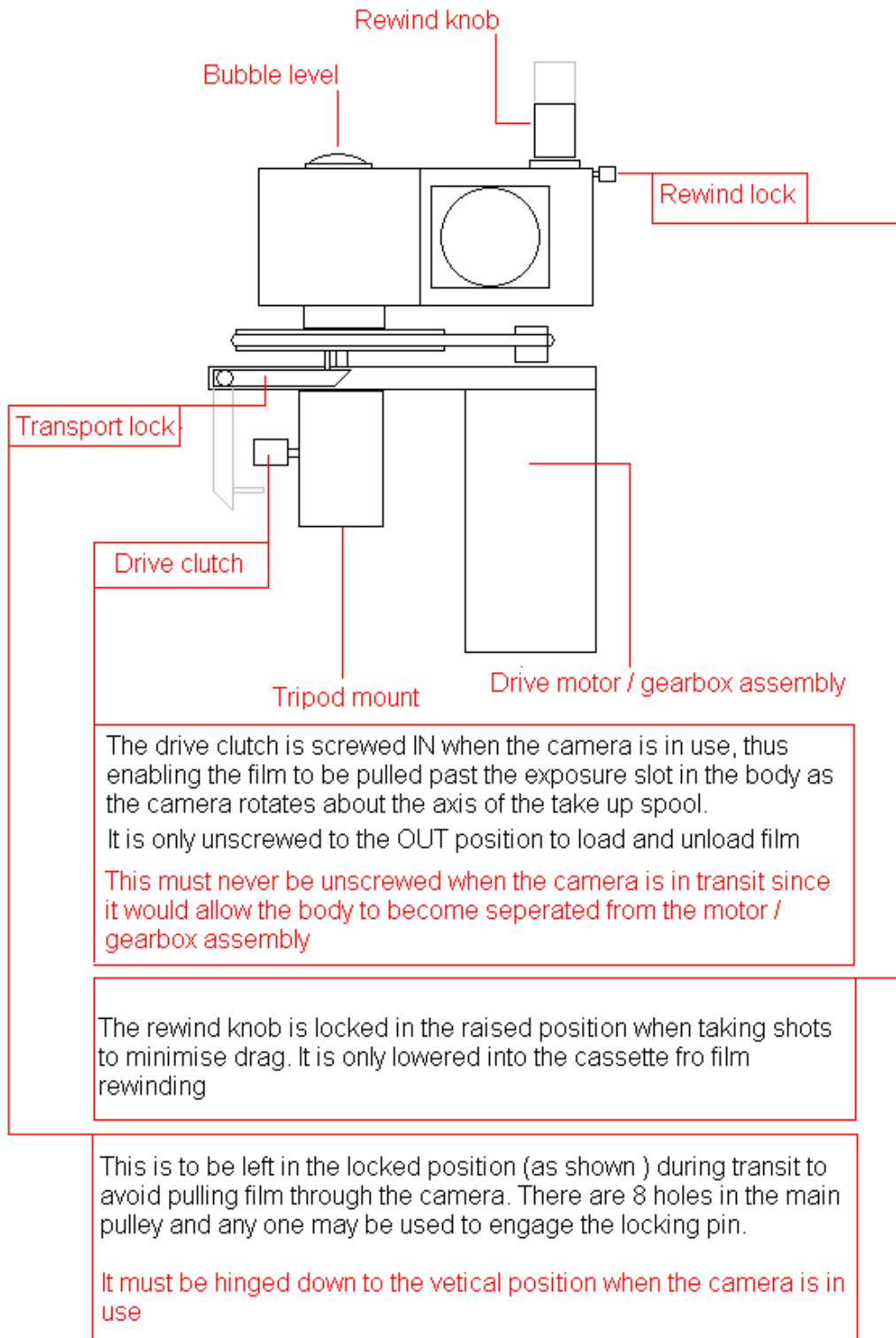

Negative layout on film

The negatives produced by a rotational camera are unlike a normal 35 mm design, since there is no such thing as a “frame”, A normal 35 mm neg strip will appear as shown below.

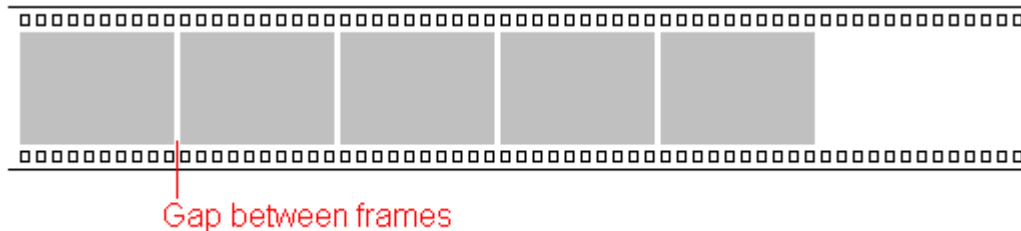

In a rotational, the concept of a discrete frame does not exist, the end of one shot and the start of another is as shown by a dense bar where the film was being continuously exposed when the camera was not rotating as shown below

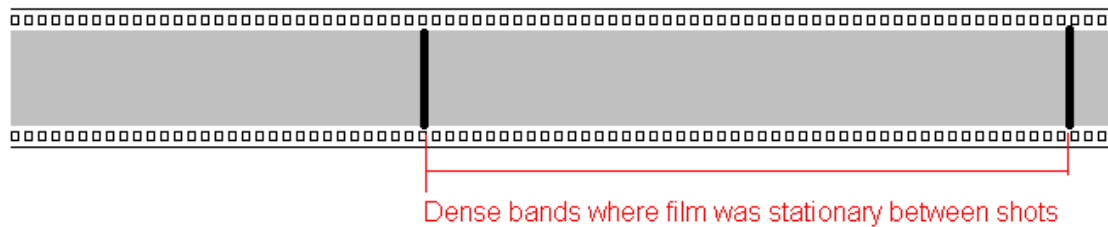

Another unusual feature is the fact that the subject will appear twice on a negative if the camera rotates a full 360 degrees. In fact if the camera was switched on and allowed to rotate , the negative would contain 8 repeated images without a dividing black bar

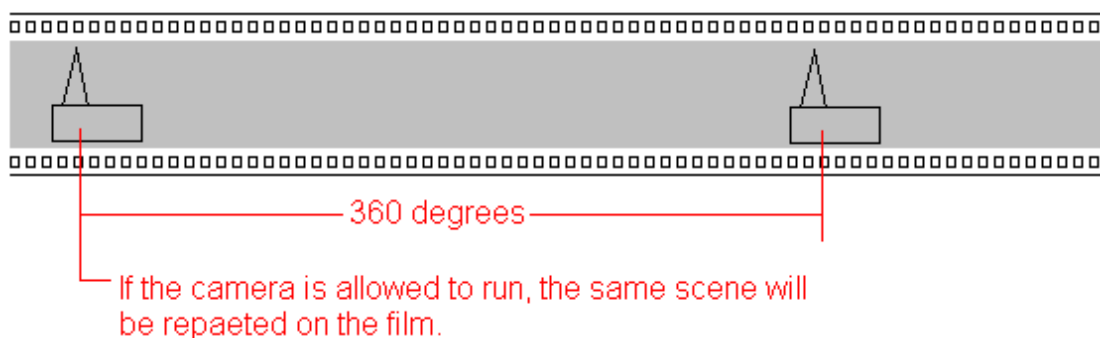

For a full 360 degree shot it is in fact advisable to allow at least 60 degrees on either side to bracket the required shot.